

33191	FACADE POELE HIRVIK V01 EM	1
33128	DEFLECTEUR DESSOUS	1
32593	TRAVERSE SUPERIEURE	1
32591	DESSUS	1
32589	COTE HABILLAGE	2
32588	TOLE DE PROTECTION BUCHER	1
32587	TRAVERSE SUPPORT CDC	2
32586	MONTANT	2
32585	FACE AVANT/ARRIERE	2
32584	PLAQUE DE SOL	1
32583	DEFLECTEUR ARRIERE	1
32189	COLLERETTE SORTIE VERTICALE	1
32084	SOUS COLLERETTE PERFORE	1
26572	AILETTE	1
16920	ENTRETOISE LG 16	6
15673	OBTURATEUR ARRIERE	1
CODE ARTICLE	DESIGNATION	QTE

28690	TAMPON TOLE	1
28689	BUSE FONTE DIA.150/153	1
27469	CHENET	1
27299	PLAQUE D'ATRE ONDE	1
26334	DEFLECTEUR VITRE	1
26100	SOUS-ENSEMBLE CORPS DE CHAUFFE	1
17340	DOUBLAGE DEFLECTEUR DE FUMEE	1
17294	CALAGE DEFLECTEUR	3
17237	DEFLECTEUR VERMICULITE	1
17165	TIRETTE AIR DE GRILLE	1
17011	REGISTRE D'AIR	1
16999	PATTE D'ACCROCHAGE	2
16996	EQUERRE	2
16995	APPUI ARRIERE DE SOLE	1
16994	COTE INTERIEUR DE CORPS DE CHAUFFE	2
16971	RESSORT DE FERMETURE PB50	1
16783	SOLE	1
09951	ENS.SOUDE CENDRIER	1
CODE ARTICLE	DESIGNATION	QTE

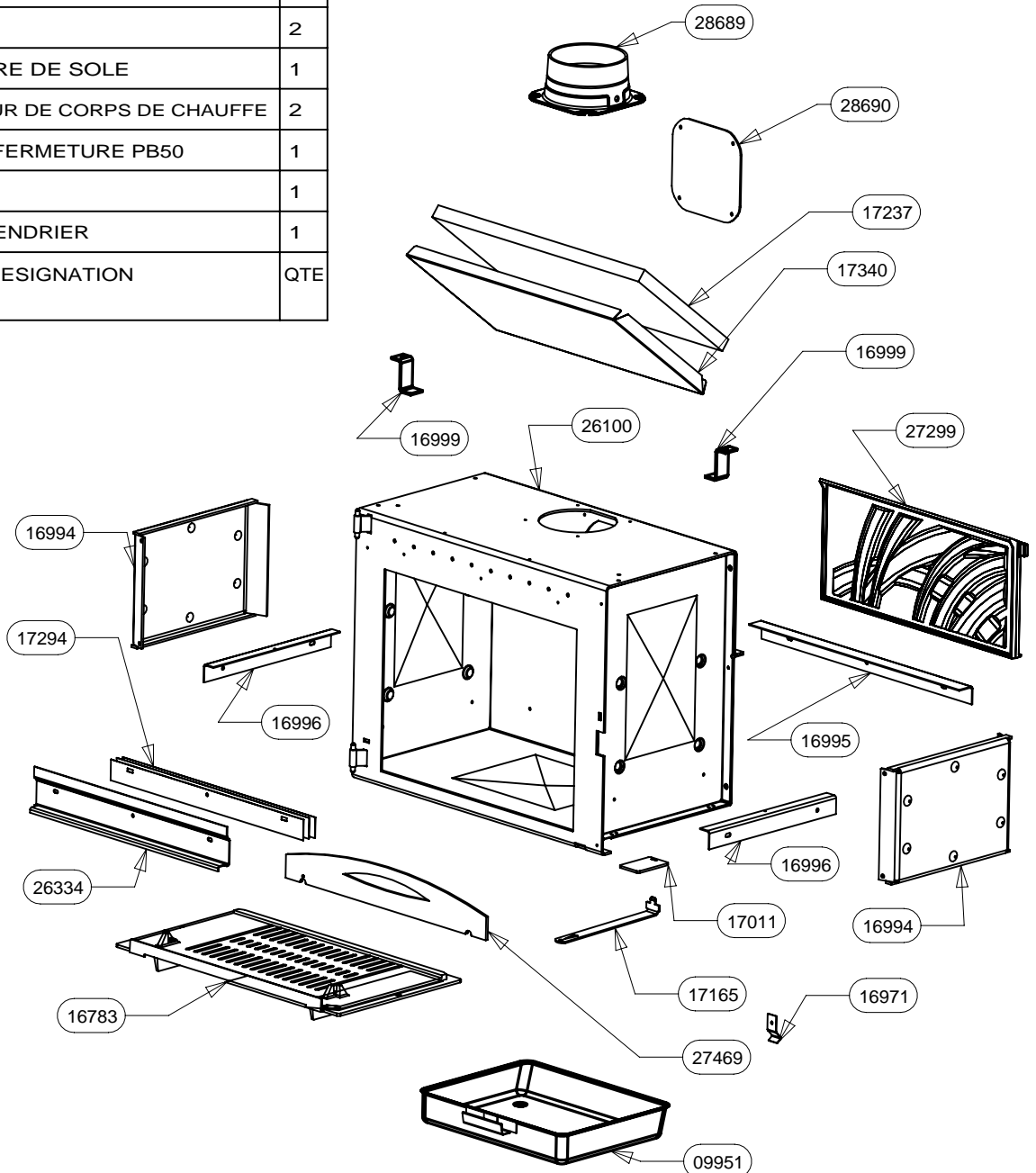

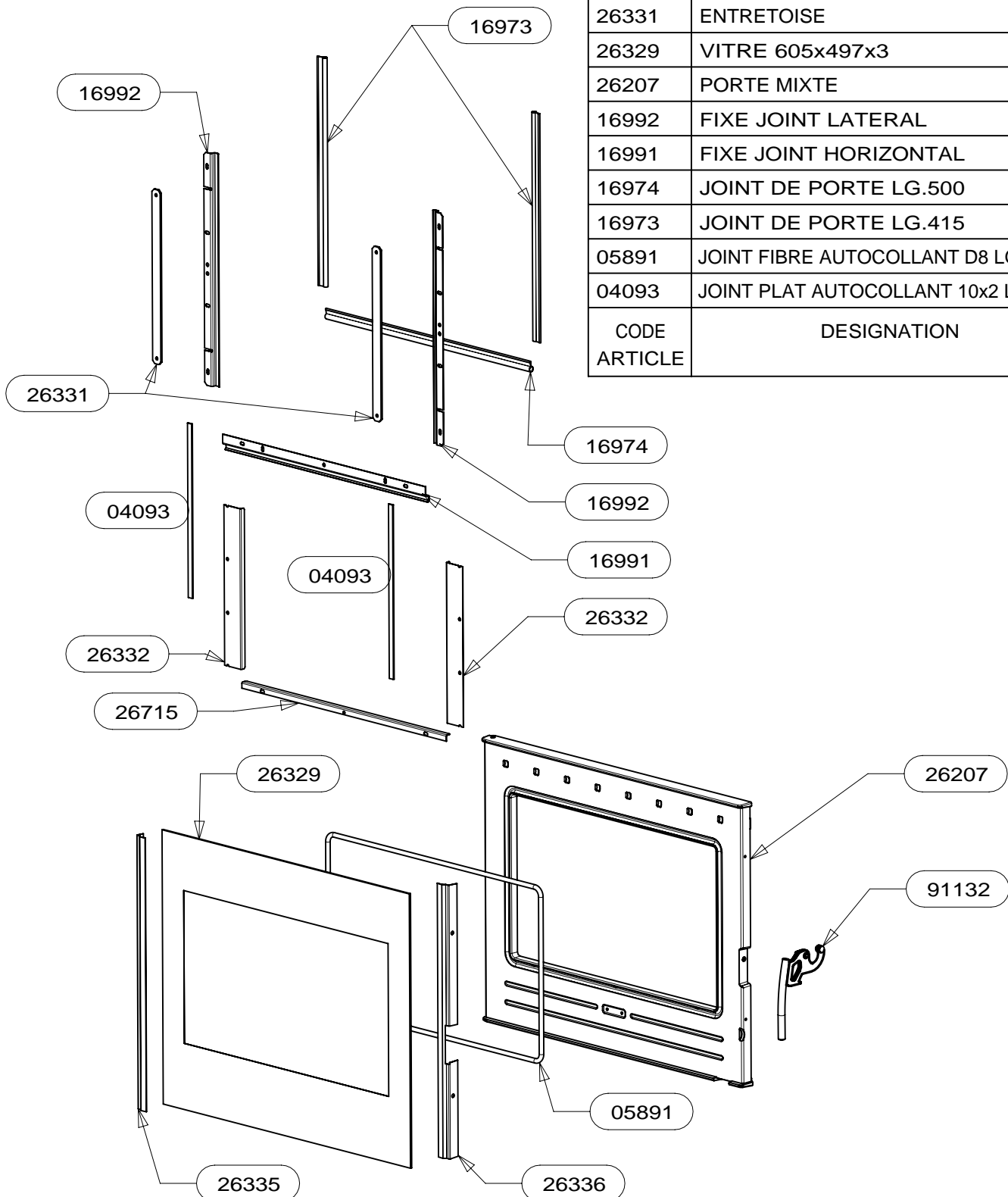

91132	ENSEMBLE MONTE POIGNEE RONDE	1
26715	BAVETTE	1
26336	FIXE VITRE DROIT	1
26335	FIXE VITRE GAUCHE	1
26332	PROTEGE JOINT	2
26331	ENTRETOISE	2
26329	VITRE 605x497x3	1
26207	PORTE MIXTE	1
16992	FIXE JOINT LATERAL	2
16991	FIXE JOINT HORIZONTAL	1
16974	JOINT DE PORTE LG.500	1
16973	JOINT DE PORTE LG.415	2
05891	JOINT FIBRE AUTOCOLLANT D8 LG 1800	1
04093	JOINT PLAT AUTOCOLLANT 10x2 LG.320	2
CODE ARTICLE	DESIGNATION	QTE